

INSTALLATION MANUAL – AW50 / AW50D / AW64 CURTAINWALL OPENINGS

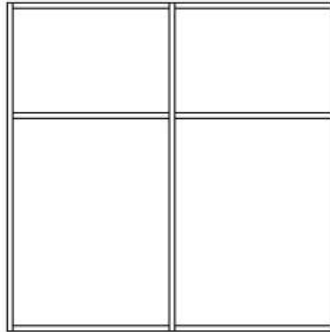

CW

SYSTEM DESCRIPTION

- Extruded and filled aluminum curtainwall framing, tested and approved by **UL**
- Clear, fire-rated safety glazing

REQUIRED TOOLS

- Power drill
- Heavy-duty glass handling tools
- Rubber mallet
- Knife
- Tape measure
- Level

REQUIRED MATERIALS (PROVIDED BY ALUFLAM)

Interior Application

AW50 & AW50D Systems

- ACC17: Calcium Silicate Setting Blocks
- ASR13: Glazing Clip Screw, 7.5 x 52 mm
- ASR35: Pressure Plate Screw, 5.5 x 38 mm
- AW50GC24: Glazing Clip for Glass

AW64 System

- ACC17: Calcium Silicate Setting Blocks
- 7.5X72ZYT30: Glazing Clip Screw, 7.5 x 72 mm
- 5.5X25A2DIN7981T25: Pressure Plate Screw, 5.5 x 25 mm
- AW64GC24: Glazing Clip for Glass

Exterior Application

- ACC17: Calcium Silicate Setting Blocks
- ASR13: Glazing Clip Screw, 7.5 x 52 mm
- ASR37: Pressure Plate Screw, 5.5 x 50 mm
- AW50GC39: Glazing Clip for Glass
- WPC-01: Plastic End Cap

- ACC17: Calcium Silicate Setting Blocks
- 7.5X72ZYT30: Glazing Clip Screw, 7.5 x 72 mm
- 5.5X45A2DIN7981T25: Pressure Plate Screw, 5.5 x 45 mm
- AW50GC24: Glazing Clip for Glass
- WPC-02: Plastic End Cap

Additional Items Sent w/ Disassembled Units

- 8 x 5/8 Flat Head Sheet Metal Screws

REQUIRED MATERIALS (NOT PROVIDED BY ALUFLAM)

- Mineral wool insulating material
- For exterior applications: DOWSIL 791 Silicone Weatherproofing Sealant or other sealant suitable for metal finish and substrate conditions.
- UL Listed Fire Caulk Sealant (such as 3M Fire Barrier Sealant 1000NS, Dow 790 or equivalent) for finishing perimeter caulk joint.
- Unless otherwise specified on shop drawing or 3rd party Engineering Analysis, ¼” diameter flat head steel anchor – type and length suitable for substrate.

**REQUIRED MATERIALS (NOT PROVIDED BY ALUFLAM) FOR ALTERNATE
CONTINUOUS GLAZING CHANNEL INSTALLATION.
(SEE ALTERNATE DETAILS ON PAGE 9)**

- Glazing Tape for contact point of Steel Glazing Channel to Glass
- Backer Rod (if needed)
- For exterior applications: DOWSIL 791 Silicone Weatherproofing Sealant or equivalent for finishing over intumescent tape/backer rod, and to additionally seal around channel as needed.

- **TABLE OF CONTENTS**

General Installation Notes	Page 1
Installation	Page 3
Determine Frame Reference Point	Page 3
Unpack Frame	Page 3
Multiple Frames	Page 3
Exterior applications	Page 4
Installation of Frame	Page 5
Prepare for Glazing	Page 5
Glazing	Page 6
Finishing	Page 7
Figure: Overview	Page 8

GENERAL INSTALLATION NOTES

1. Do not drop, roll or drag boxes of aluminum framing. Move and stack boxes with proper support to prevent distortion. If forklifts are used, be especially careful about striking the boxes when lifting or moving.
2. Store in a dry, out of the way area. If rain exposure, condensation or any water contact is likely, then all packaging material should be removed. Wet packaging materials will discolor and may stain aluminum finishes and paints.
3. All materials should be checked for quantity and quality upon receipt. Aluflam must be contacted immediately about any discrepancies in shipment. Check to make sure that you have the required supplies and tools necessary for the installation.
4. Carefully check the openings and surrounding construction that will receive your material. Remember, if the construction is not per the construction documents, it is your responsibility to notify the general contractor in writing. Any discrepancies must be brought to the general contractor's attention before you proceed with the installation.
5. Collect your shop drawings, materials, packing list, and this installation manual. Carefully review parts location, the sequence of installation, when you glaze it, and how you seal it. Installation instructions are of a general nature and may not address every condition you will encounter. The shop drawings were prepared specifically for the project.
6. Any material substitutions must be of equal or greater quality. Consult Aluflam prior to substituting any material to ensure that the products' fire ratings are not violated.
7. Remember to isolate, in an approved manner, all aluminum from uncured masonry or other incompatible materials.
8. System-to-structure fasteners are not supplied by Aluflam. Fasteners called out on shop drawings are to indicate minimum sizes.
9. If any questions arise concerning Aluflam products or their installation, contact Aluflam for clarification before proceeding.
10. Aluflam product installation is frequently completed before drywall, flooring and other products. Take the extra time to wrap and protect the installed material.
11. Cutting tolerances are $\pm 1/32"$, unless otherwise specified.
12. Concrete, mortar, plaster, muriatic acid and other alkaline and acid based construction and cleaning materials may be very harmful to frame finishes and should be removed with water and mild soap immediately or permanent damage or staining of the finishes may occur. A spot test is recommended before any cleaning agent is used, and abrasive type cleaners must never be used.

13. Frames are never to be used as ladders, step stools, scaffolds or scaffold supports.
14. All work must start from, and be referenced to benchmarks, offset lines and/or column centerlines established by the architectural drawings and the general contractor.
15. All frames must be installed plumb, square, level and true, and in accordance with approved shop drawings.
16. Glass and glazing building codes governing the design and use of products vary widely. Aluflam North America, LLC does not control the selection of the products, product configurations, operating hardware and function, or glazing materials, and Aluflam assumes no responsibility for these design considerations. It is the responsibility of the design professional, owner, architect, specifier, general contractor, and the installer to make these selections in strict accordance with all applicable codes.
17. The exterior curtainwall frame system is designed so that any moisture that penetrates the exterior plane drains down the vertical profiles and out at the sill. The horizontal mullions are notched and fit between the vertical mullions. This allows for any moisture that enters the system to move across the horizontal members and then down the vertical members.
18. Weatherproofing performance requirements shall be determined by the design professional, owner, architect, specifier, general contractor and or installer. All parties should develop an approach that satisfies the performance requirements of the project. Weatherproofing the frames shall be the responsibility of the installer. It is recommended to perform field water tests on initial mock-up installation(s) to confirm performance and adjust as necessary before installing the rest of the frames and glass.

INSTALLATION

STEP 1 DETERMINE FRAME REFERENCE POINT

Establish the frame reference lines or the exterior/interior plane of the frames to be installed using either bench marks, offset lines, or column centerlines provided by the general contractor and referenced on the shop drawings. Use the established reference points to determine the installation points for each frame opening at the head, and jambs.

STEP 2 UNPACK FRAME

- a. Remove loose components, such as pressure plates, glass clips, intumescent strips, gaskets, covers, fasteners, etc, and set aside in a well protected area.
- b. Carefully lift frame out of packaging. At this point, the frame joints are unprotected. Handle the frame with extreme care to avoid separation of corner joints.

STEP 3 MULTIPLE FRAMES

- a. In the case of attached, multiple frame sections – assemble the frame sections into larger units prior to installing into the wall opening (see example).

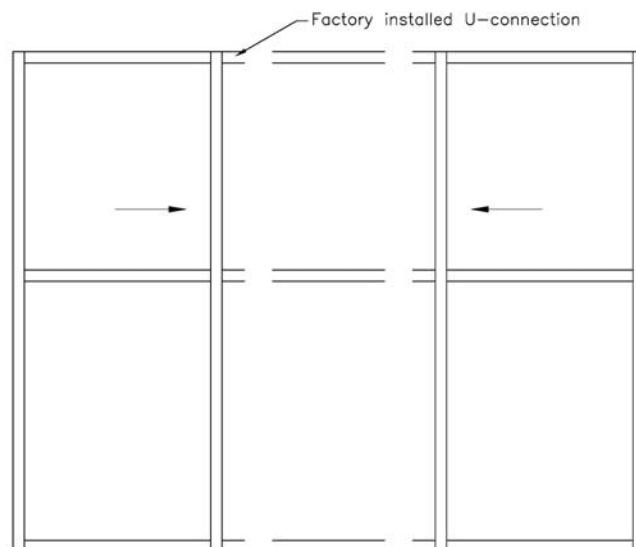

- b. Lay out all frames to be attached on a smooth, dry surface. Ensure that frames are well protected from abrasion and impact. Strips of wood are very suitable for this purpose.
- c. U-connections are factory installed to the vertical mullions in accordance with shop drawings.

- d. Slide horizontal members onto U-connections and secure joints through factory pre-drilled holes.

NOTE: For exterior applications, follow instructions below:

- i. Apply DOWSIL 791 Silicone Weatherproofing Sealant, or other sealant suitable for metal finish and substrate conditions, to surfaces as shown in Figures 1 and 2 below:



Figure 1

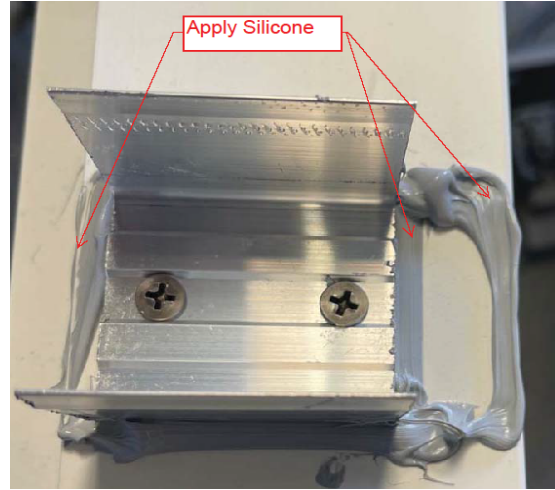

Figure 2

- ii. Slide horizontal members onto “T” brackets as shown in Figure 3. Secure joints through factory pre-drilled holes as shown in Figure 4:



Figure 3

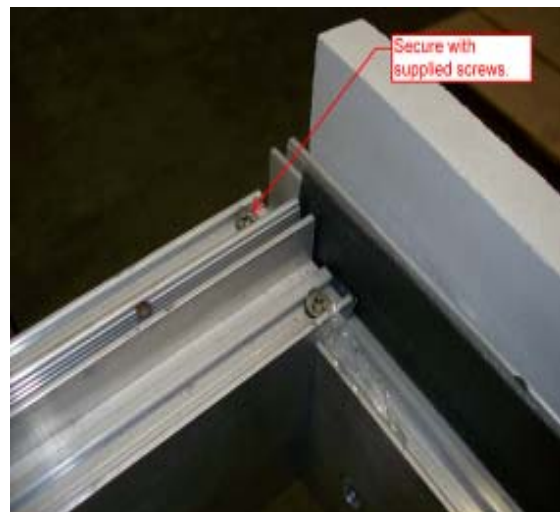

Figure 4

- iii. Wipe off excess silicone as needed.
- iv. Cut vertical and horizontal gaskets to length, see Figure 5. Trim gasket so it sits flat once placed over silicone, see Figure 6. Apply DOWSIL 791 Silicone Weatherproofing Sealant or equivalent, in corners where the gaskets connect and place gasket over silicone as shown below in Figures 7 & 8. Wipe as needed.

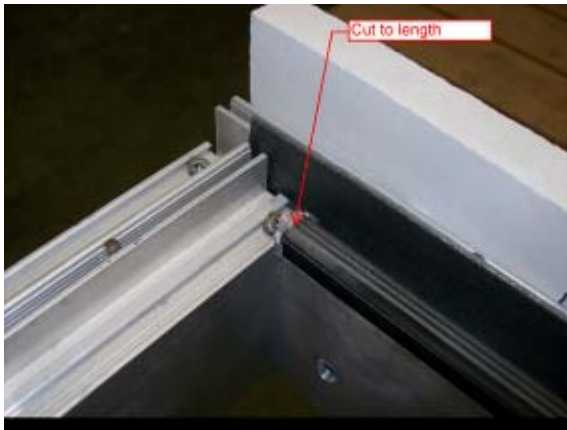

Figure 5



Figure 6

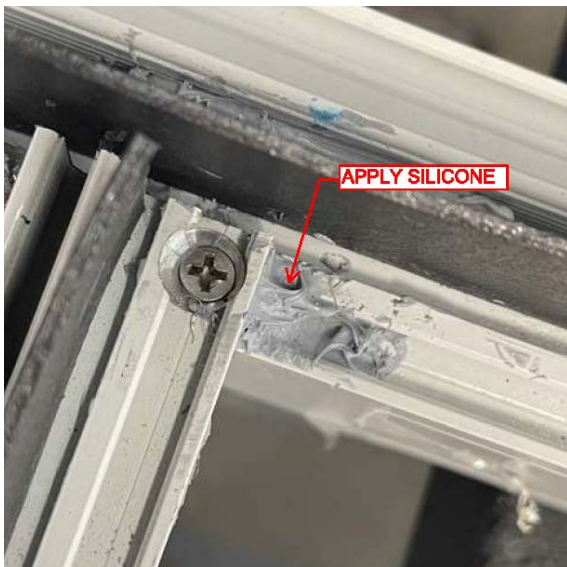

Figure 7



Figure 8

- v. The curtainwall system is designed so that any moisture that penetrates the exterior plane drains down the vertical profiles and out at the sill. The horizontal mullions are notched and fit between the vertical mullions. This allows for any moisture that enters the system to move across the horizontal members and then down the vertical members.

Apply DOWSIL 791 Silicone Weatherproofing Sealant or equivalent at the joints to seal the horizontal to vertical connection and tool to create a “ramp” along the vertical profile to help moisture drain down the profile as shown in Figures 10 and 11.



Figure 10

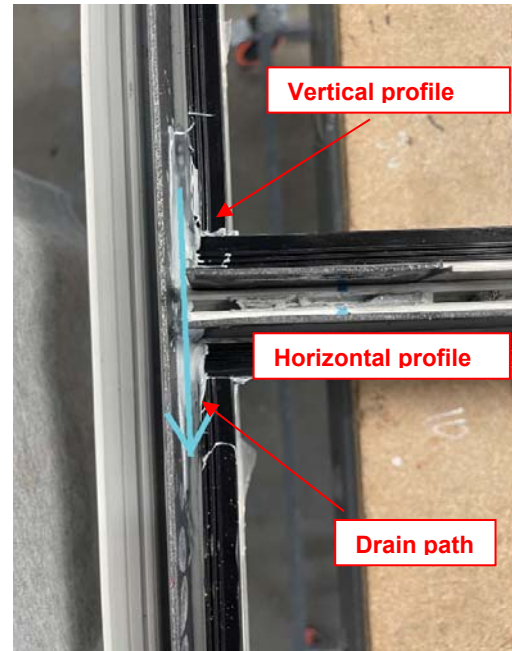

Figure 11

- vi. Create a ring of silicone around the concrete filled insert at the ends of the profiles (top and bottom) and apply plastic sheets (part number WPC-01) by Aluflam. Secure plastic sheets in place with fastener through the concrete fill. The plastic sheets will provide a smooth surface for the silicone to adhere to and the ends of the profile. See Figures 12, 13 and 14.



Figure 12



Figure 13



Figure 14

STEP 4 INSTALLATION OF FRAME

- a. Install the frame plumb, square, level and true.
- b. Measure the size of the frame and ensure that it meets the dimensions referenced on the shop drawing.
- c. Anchor the frame to surrounding fire-rated structure using structurally sound anchoring method (perimeter bolting, bolted to steel channels, etc.)
- d. Ensure that frame dimensions have not changed.

STEP 5 PREPARE FOR GLAZING

- a. Inspect the factory installed gaskets in the frame opening and make sure it hasn't shifted during installation.
- b. Make sure intumescent band does **not** cover the stainless steel setting block platforms. If needed, cut the band. See Figure 15.
- c. Place calcium silicate setting blocks (by Aluflam) on top of stainless steel platforms. See Figure 16.



Figure 15

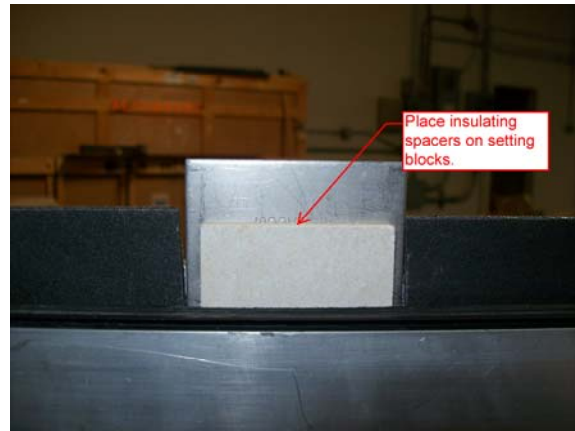
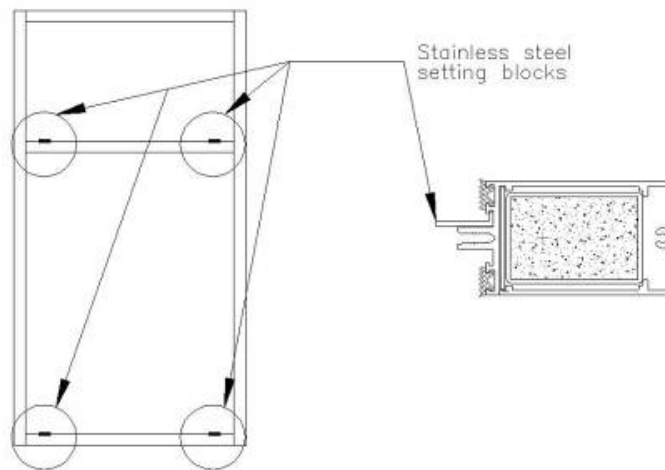

Figure 16



STEP 6 GLAZING

The Contraflam glass products that are used in Aluflam frame systems are heavy and fragile. Make sure that proper tools and lifting capacity are available prior to opening glass crate.

Avoid impact with any metal objects and avoid setting the glass down directly onto floor. Use wood strips or other suitable material for setting down the glass section prior to installation.

For full instructions on handling and installing glass, please refer to Vetrotech Saint-Gobain's installation instructions.

- a) Center the glass in the frame opening and carefully set the unit down onto the setting blocks.
- b) While supporting glass in place, secure it by fastening stainless steel glass clips at pre-drilled locations. **NOTE – THE STAINLESS STEEL GLASS CLIPS**

- ARE KEY TO THE PERFORMANCE OF THE ALUFLAM CURTAINWALL SYSTEM AND MUST BE INSTALLED.**
- c) Attach pressure plates at pre-drilled locations. **NOTE – CENTER THE PRESSURE PLATES SO THE GASKET OVERLAP THE STAINLESS GLASS CLIPS ON BOTH SIDES. FAILURE TO DO SO CAN RESULT IN LEAKAGE.**
 - d) Snap on covers.

NOTE: For exterior applications, follow instructions below:

Apply DOWSIL 791 Silicone Weatherproofing Sealant or equivalent into pre-drilled holes for glass clips. See Figure 17.



Figure 17

For exterior installation, it is critical that the fire glass portion of the IGU is facing the interior, temperature-controlled space. IGU Glass units should be labeled with “THIS SIDE IN” sticker from the Vetrotech (Glass) factory but if it is not, look for the breather tube placed in the airspace. This will be closer to the exterior surface of the glass and the Low-E outboard lite and should be put toward the exterior. See example photo below, Figure 18.

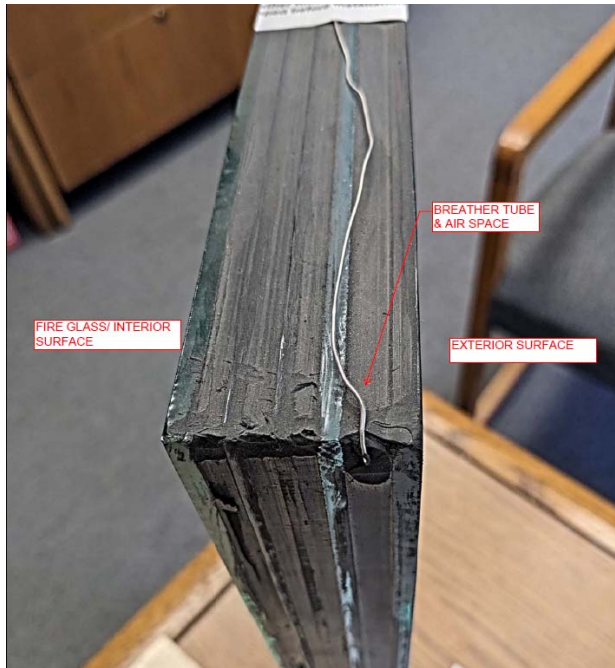

Figure 18

STEP 7 FINISHING

- a. Fill space between curtainwall back-member and substrate with mineral wool insulating material. Pack as tightly as possible.
- b. Apply and tool UL Listed Fire caulking to form continuous seals #2 and 3 shown in Figure 19. Use 3M Fire Barrier Sealant 1000NS or other equivalent UL Listed sealant. These are mandatory to comply with fire and weather performance requirements.
- c. Seal #1 shown in Figure 19 will be necessary for weatherproofing exterior frames. Leave gaps (in seal #1 only) under ends of vertical caps and pressure plates to allow moisture to exit the frames. See Figure 20.

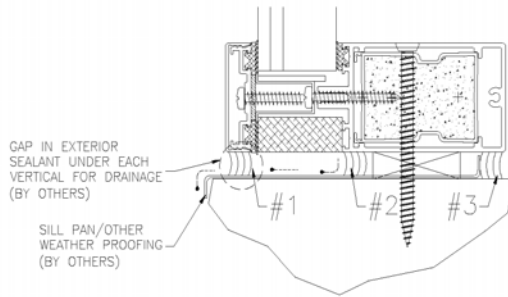

Figure 19



Figure 20

- d. Clean glass units using mild glass cleaner. For further information, refer to Vetrotech's glass cleaning and maintenance instructions.

